

LED Wall Sconce

WS93730
INSTALLATION SHEET

START FROM HERE

- Make sure **POWER** is **COMPLETELY OFF** at the fuse box
- Have your fixture installed by a qualified licensed electrician
- Prepare everything in a clear area
- Wear gloves at all time during this installation
- Read instructions carefully before you start assembly
- Keep this installation sheet for future reference

Please Note:

- For dimming, a TRIAC type of dimmer is required.

Technical Support: 1-855-855-8926

- 1.** Remove the fixture from its original packaging. Remove the mounting plate (**1c**) from within the canopy (**2b**) by removing the two screws (**2a**). Pull out the mounting plate (**1c**) from within the canopy (**2b**) and attach to the electrical junction box (**1a**) using the two screws (**1d**) provided in the hardware package. Make sure to reinforce the wood behind the drywall for extra support and use the wood screws or anchors (**1e,1f**) to secure the mounting plate (**1c**) to the wall.
- 2.** Connect all wiring with the provided marrettes (**1b**) (white to white "N", black to black "L", ground to ground "G"). Attach the canopy (**2b**) to the mounting plate (**1c**) and secure with two screws (**2a**).
- 3.** You have now completed the installation of your fixture, do enjoy.

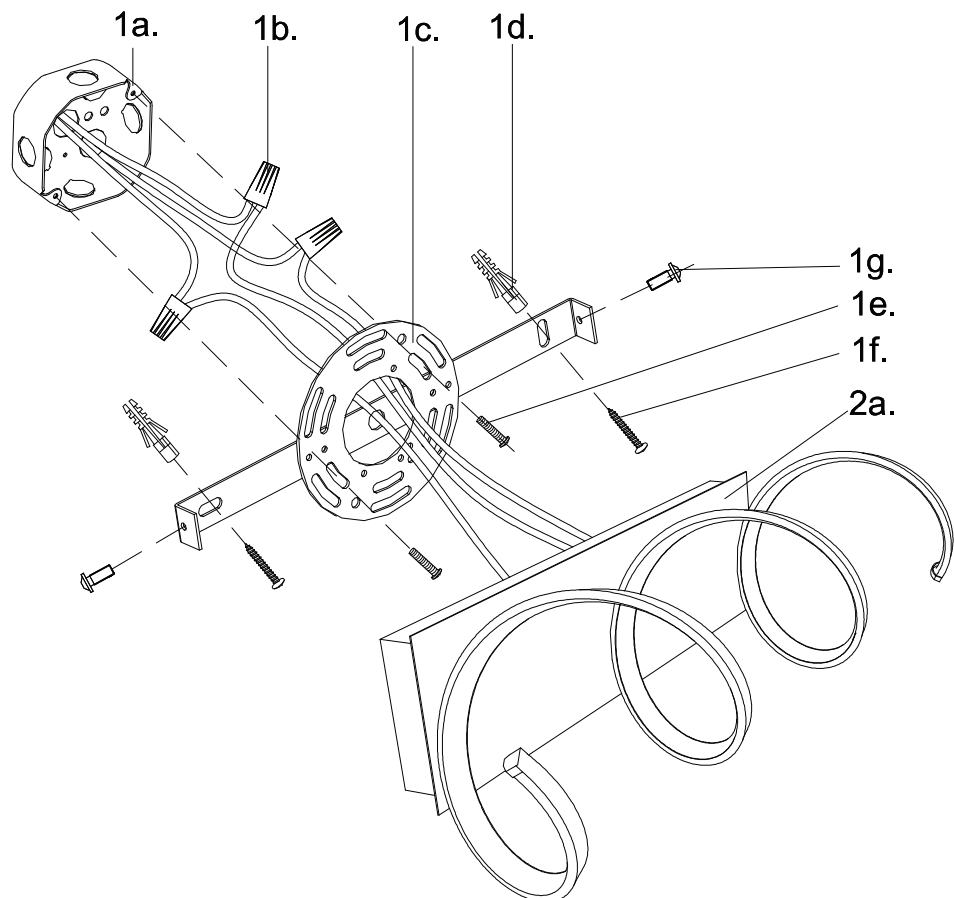

KUZCO

19054 28th Avenue Surrey, BC Canada V3Z 6M3
T: 604 538 7162 TF: 1-855 85 KUZCO F: 604 538 7196
W: kuzcolighting.com
20181127